

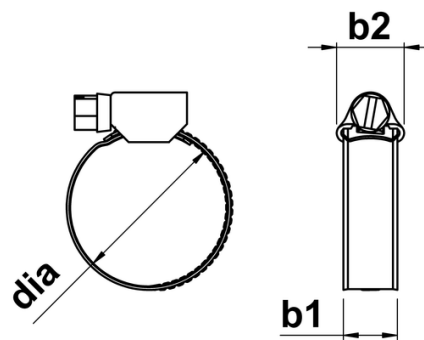

Hose Clips DIN 3017 12mm band in A4 Stainless Steel

The standard DIN 3017 non-perforated, worm drive hose clip. Perhaps the most popular hose clip currently in use worldwide. A sympathetic design helps guard against hose impingement and the smooth low friction worm drive allows for a strong clamping force. This version has a 12mm band width and is manufactured from A4 grade stainless steel.



band width (b1)	12mm
maximum housing width (b2)	20mm
material	A4 stainless steel