

BWZP19-5.5-25-3

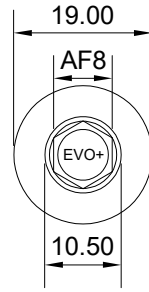

BWZP19-5.5-38-3

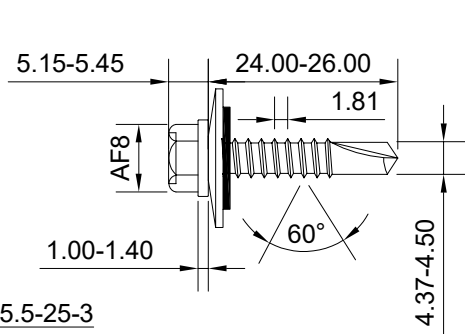
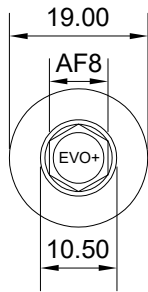
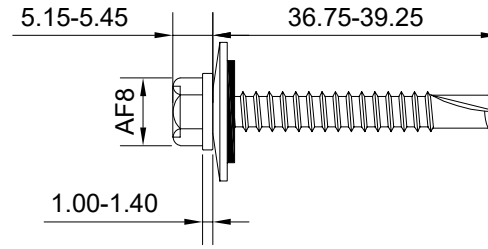

BWZP19-5.5-50-3

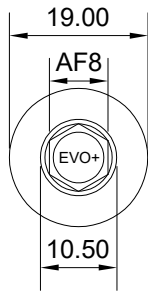
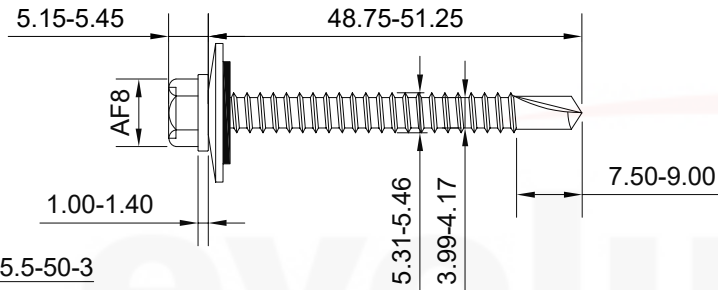

BWZP19-5.5-75-3

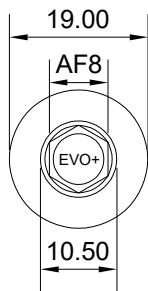
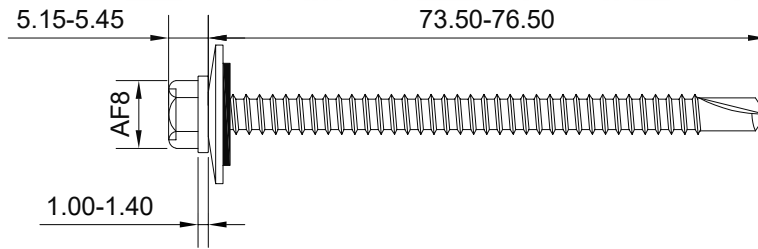

BWZP19-5.5-100-3

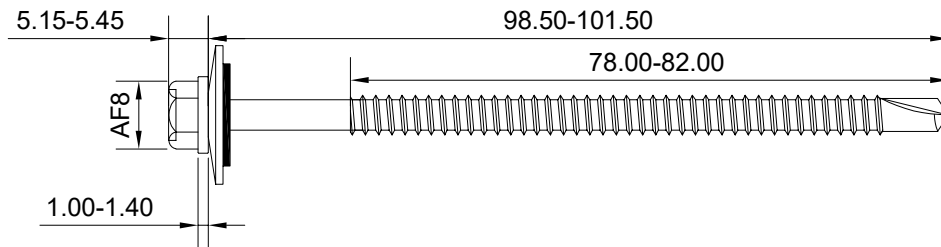

PLEASE NOTE:

1. DO NOT SCALE
2. All dimensions in millimeters unless otherwise noted. Structural sections to be designed by others. Evolution fasteners specified in accordance with material loads provided by project specific Engineer. Evolution fasteners must be installed as per best practice or manufacturers guidelines.
3. Due to the nature of the product, this drawing is provided strictly without prejudice, without recourse, without liability, non-assumpsit, no assured value, errors and omissions excepted, subject to change without notice and all rights reserved. This drawing remains the intellectual property of Evolution Fasteners UK Ltd and must not be copied, altered or reproduced without the expressed, written approval of Evolution Fasteners UK Ltd. This drawing supersedes all previous versions and is subject to change without notice, as such dimensions may not match historical stock or product.

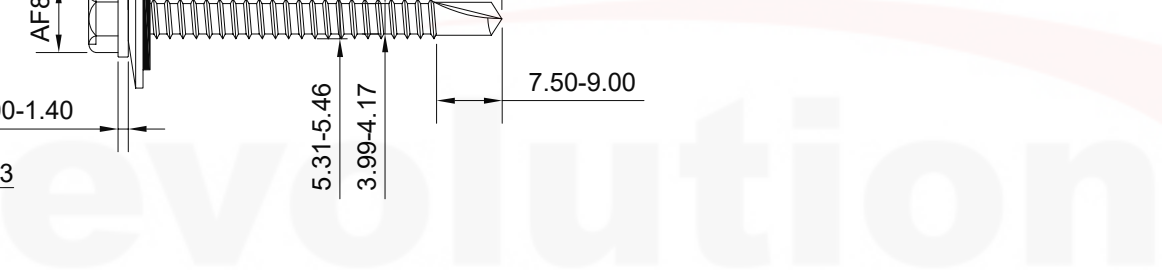

Evolution Fasteners UK Ltd

DESCRIPTION:	SHEET:	ISSUE:
BWZP19 TEK 3 RANGE	01	C

FASTENER & WASHER MATERIAL GRADE:
Carbon Steel (C1022 grade)

COATING:
Electroplated Zinc $\geq 5\mu\text{m}$

